

MVH4000D Series

High Performance Digital Relative Humidity & Temperature Sensor

GENERAL DESCRIPTION

[Patents protected & patents pending]

MEMS Vision's relative humidity (RH) and temperature (T) sensors are built by combining the company's revolutionary MoSiC[®] technology with its extensive ASIC design experience. This combination enables high levels of performance, such as fast RH measurement response time and high accuracy.

The technology also offers a very robust proprietary sensor-level protection, ensuring excellent stability against aging and harsh environmental conditions such as shock and volatile chemicals.

The highly miniaturized smart sensors are fully calibrated and provide standard digital I²C outputs to enable plug-and-play integration. The output RH & T resolutions can be independently programmed for maximum flexibility and to minimize power consumption, depending on the application and operating conditions.

The micro-Watt levels of power consumption of these sensors make them the ideal choice for portable and remote applications.

MEMS Vision's combined RH/T sensors offer the industry's most competitive performance-to-price value, for a wide range of applications and end users.

FEATURES

- **Fast RH response time**
Typical 4 seconds time constant
- **High accuracy**
Relative humidity (MVH4001D): Typical: ±1.5% RH
Temperature (MVH4001D): Typical: 0.2°C
- **Independent resolution settings for RH and T**
8, 10, 12 or 14 bits
- **Fully compliant I²C interface**
- **Extended supply voltage range of 1.71V – 3.6V**
- **Very low power consumption**
0.3 µA avg. current at one temperature meas. per second (8-bit res., 3.3V supply)
- **Small form factor for use in compact systems**
2.5 x 2.5 x 0.9 mm DFN-style LGA package

USER BENEFITS

- **Long Term Stability and Reliability:**
Proprietary sensing structures and protection technology, robust biasing circuitry, and self-diagnosis algorithms ensure accurate and repeatable measurements.
- **Digital Output:**
Allows for native interfacing with embedded system components such as FPGAs or off-the-shelf microcontrollers.
- **Fully Calibrated System:**
Built-in digital sensor calibration ensures high accuracy measurements and linear behavior under varying sensing environments.

APPLICATIONS

The MVH4000D series is ideal for use in environmental sensing for consumer electronics, automotive, industrial, agricultural, and other sectors. Some application examples include:

- | | | |
|---------------------|---------------------------|---------------------------|
| ● OEM products | ● Battery-powered systems | ● Smartphones and tablets |
| ● Instrumentation | ● Drying | ● HVAC systems |
| ● Medical equipment | ● Meteorology | ● Building automation |
| ● White goods | ● Refrigeration equipment | ● Data logging |

Table Of Contents

1	Pin Configuration	5
2	Pin Assignment and Application Circuit.....	5
3	Functional Description	5
4	Chip Performance Summary.....	7
5	Relative Humidity and Temperature Tolerances.....	9
5.1	Accuracy Tolerances.....	9
5.2	Normal Operating Conditions	10
6	User Guide	11
6.1	Sensor Communications.....	11
6.2	Performing Measurements with the MVH4000D Series Sensors.....	12
6.2.1	Performing a Hold Measurement	13
6.2.2	Performing a No-Hold Measurement	13
6.2.3	Interpreting the Data	14
6.2.4	Measurement Conversion Times.....	15
6.2.5	CRC Checksum Calculation	15
6.3	Periodic Measurement Mode	16
6.4	Alert Feature.....	17
6.4.1	Alert Pin – Measurement Active	17
6.4.2	Alert Pin – Humidity / Temperature Threshold Detection	17
6.5	Accessing Configurable Sensor Registers.....	19
6.5.1	Read Register Command	19
6.5.2	Write Register Command.....	20
6.6	Configuration Bits.....	21
6.6.1	Setting the Measurement Resolution	21
6.6.2	Periodic Measurement Settings.....	21
6.6.3	Alert Feature Settings	22
6.7	Reading the Sensor ID Number	24
6.8	I ² C Timing Specifications	26
7	Package and PCB Information	27
7.1	Package Drawing.....	27
7.2	Tape and Reel Information	28
7.3	Soldering Information.....	28
7.4	PCB Layout Considerations.....	29
8	Storage and Handling Information.....	29

List Of Tables

Table 1: Pin Assignment.....	5
Table 2: MVH4000D Series Specifications.....	7
Table 3: Commands Code and Description.....	12
Table 4: Measurement Command Modes.....	12
Table 5: Conversion Times.....	15
Table 6: CRC Checksum Properties.....	15
Table 7: Alert status bits.....	18
Table 8: Temperature and Humidity Measurement Resolution Settings.....	21
Table 9: Periodic Measurement Settings.....	21
Table 10: Alert Feature Settings.....	22
Table 11: I ² C Timing Parameters.....	26

List Of Figures

Fig. 1: Diagram of pin configuration (top view).....	5
Fig. 2: DFN-style LGA package.....	5
Fig. 3: Application Circuit.....	5
Fig. 4: MVH4000D series functional diagram.....	6
Fig. 4: Relative humidity and temperature tolerances (RH tolerances given at T _A = +25°C).....	9
Fig. 5: Relative humidity tolerances across temperature.....	10
Fig. 6: Diagram of an I ² C interconnect with one master and three slave devices.....	11
Fig. 7: I ² C bus start and stop conditions.....	11
Fig. 8: Typical hold measurement sequence for a humidity and temperature command.....	13
Fig. 9: Typical no-hold measurement sequence for a humidity and temperature command.....	14
Fig. 10: Sequence to retrieve the latest results in periodic measurement mode.....	16
Fig. 11: Sequence to stop periodic measurements.....	16
Fig. 12: Alert Pin Functionality – Measurement Active Indicator.....	17
Fig. 13: Example of Alert Pin Functionality in Humidity / Temperature Detection Mode.....	18
Fig. 14: Data returned from MVH4000D chip when the Alert feature is enabled in Periodic Measurement Mode.....	19
Fig. 15: Read Register command sequence.....	20

Fig. 16: Write Register command sequence20

Fig. 17: Read Sensor ID command sequence..... 25

Fig. 18: I2C timing diagram.26

Fig. 19: LGA package drawing.....27

Fig. 20: LGA package land pattern (top view).....27

Fig. 21: Packaging tape drawing.....28

Fig. 22: Recommended lead-free soldering profile.....28

Fig. 23: Thermal isolation of sensor using milled PCB openings.29

1 Pin Configuration

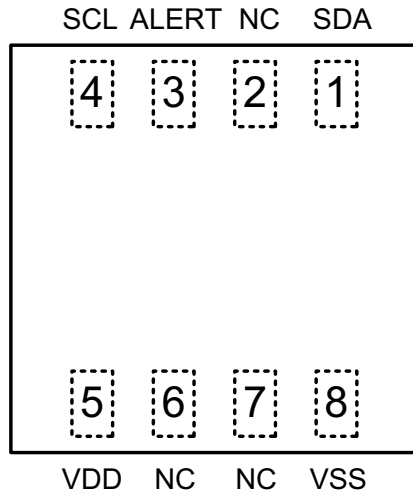

Fig. 1: Diagram of pin configuration (top view).

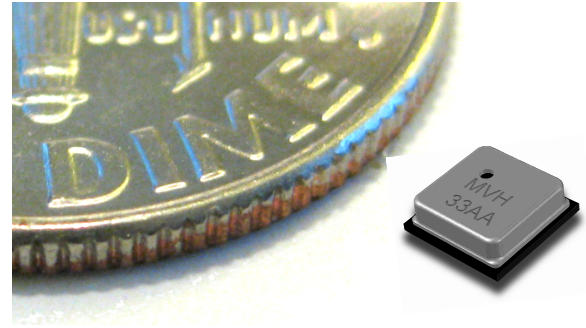

Fig. 2: DFN-style LGA package.

2 Pin Assignment and Application Circuit

Table 1: Pin Assignment.

Pin	Name	Function
1	SDA ¹	I ² C data
2	NC	No connect
3	ALERT	Digital output indicating an alarm condition. Leave floating if unused.
4	SCL ¹	I ² C clock (up to 400 kHz)
5	VDD	Positive supply
6	NC	No connect
7	NC	No connect
8	VSS	Negative supply or ground

¹Requires a 2.2 k Ω pull-up resistor.

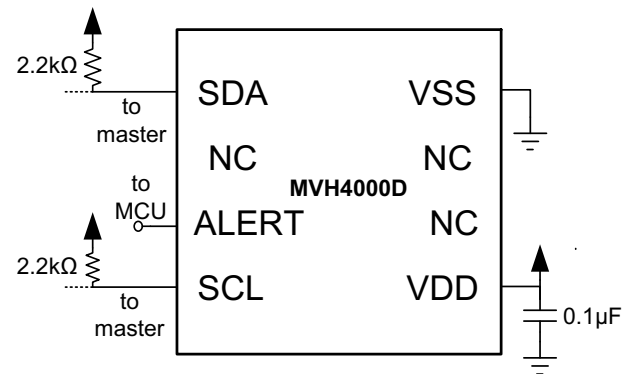

Fig. 3: Application Circuit.

3 Functional Description

The MVH4000D series sensors are highly integrated digital devices that accurately measure relative humidity and temperature levels.

An analog-to-digital converter (ADC) with a configurable resolution is interfaced with an analog multiplexer and two sensors in order to allow for the measurement of both relative humidity and temperature. High precision biasing and clock generation ensures stable operation over a wide temperature range. The sensor can be used to measure the ambient relative humidity and temperature in real-time or be used for data-logging, and can interface with any I²C compliant system for digital transmission of the acquired data.

Calibration data and compensation logic are integrated within the system, such that the chip does not require any user calibration, and is readily compensated for accurate operation over a wide range of temperature and humidity levels.

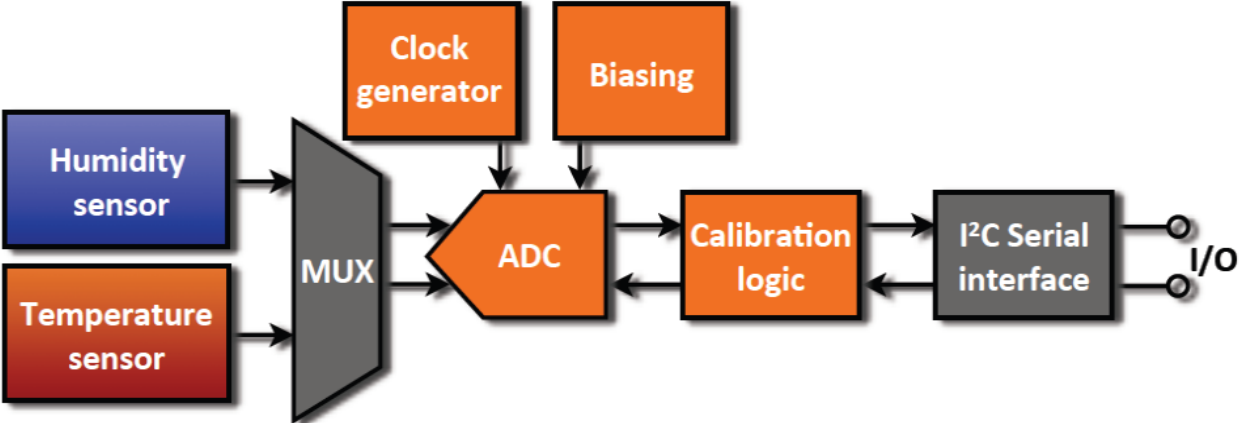

Fig. 4: MVH4000D series functional diagram.

4 Chip Performance Summary

Table 2: MVH4000D Series Specifications.

At $T_A = +25^\circ\text{C}$, $V_{DD} = +1.71\text{ V}$ to $+3.6\text{ V}$ unless otherwise noted.

PARAMETER		CONDITION	MIN	TYP	MAX	UNITS
RELATIVE HUMIDITY SENSOR						
Range			0		100	%RH
Accuracy Tolerance ²	MVH4001D	10% to 90% RH		±1.5	±1.8	%RH
	MVH4002D			±2.0	±2.3	
	MVH4003D	20% to 80% RH		±2.5	±3.5	
	MVH4004D			±3.5	±4.5	
Resolution		14 bits		0.04	0.05	%RH
Hysteresis					±1.0	%RH
Non-Linearity Response Curve	from	10% to 90% RH		±0.15	±0.25	%RH
				±0.15	±0.25	
		20% to 80% RH		±0.15	±0.25	
				±0.15	±0.25	
Long-term Stability				0.1	0.25	%RH/yr
Response Time Constant ³ (τ_H)		20% to 80% RH Still air	3.0	4.0	6.0	sec.
TEMPERATURE SENSOR						
Range			-40		125	°C
Accuracy Tolerance ⁴	from	-10°C to 80°C		±0.2	±0.3	°C
				±0.2	±0.3	
		0°C to 70°C		±0.25	±0.35	
				±0.3	±0.5	
Resolution		14 bits		0.01	0.02	°C
Response Time Constant ⁵ (τ_T)			> 2			sec.
Long-term Stability					0.03	°C/yr
Supply Voltage Dependency				0.03	0.1	°C/V

Table 2 (cont'd): MVH4000D Series Specifications

PARAMETER		CONDITION	MIN	TYP	MAX	UNITS
CHIP TEMPERATURE RANGE						
Operating Range			-40		125	°C
Recommended Storage Range			0		60	°C
Storage Range			-40		125	°C
MEASUREMENT TIME						
8 bits Resolution		Temperature and Humidity (Including digital compensation)		0.64		ms
10 bits Resolution				0.80		
12 bits Resolution				1.04		
14 bits Resolution				1.70		
SLEEP MODE						
Sleep Current	I_{SD}	25°C		0.010	0.025	μA
		-40°C to 125°C			2.5	μA
POWER SUPPLY						
Operating Supply Voltage	V_{DD}		1.71	3.3	3.6	V
SUPPLY CURRENT						
Average Current ($V_{DD} = 3.3V$)	I_Q	8 bits resolution one RH + T meas./s	0.27	0.30	0.32	μA
		10 bits resolution one RH + T meas./s	0.31	0.34	0.37	
		12 bits resolution one RH + T meas./s	0.39	0.43	0.47	
		14 bits resolution one RH + T meas./s	0.55	0.62	0.69	

²For monotonic increases in the range of 10% to 90% RH after the sensor has been stabilized at 50% RH. See Fig. 4 and Fig. 5 for more details.

³From initial value to 63% of the total variation.

⁴See Fig. 4 for more details.

⁵Response time depends on system thermal mass (e.g., PCB dimensions and thickness) and airflow.

5 Relative Humidity and Temperature Tolerances

5.1 Accuracy Tolerances

The typical and maximum relative humidity and temperature accuracy tolerances for the MVH4000D series sensors are shown in Fig. 4.

MVH4001D

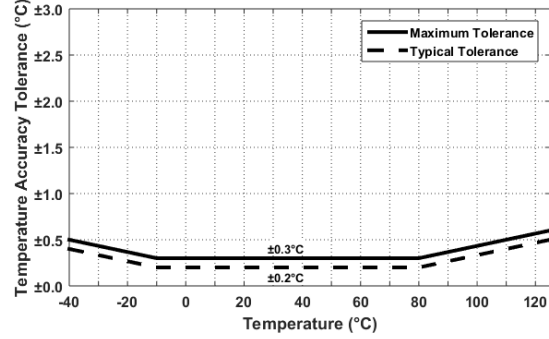
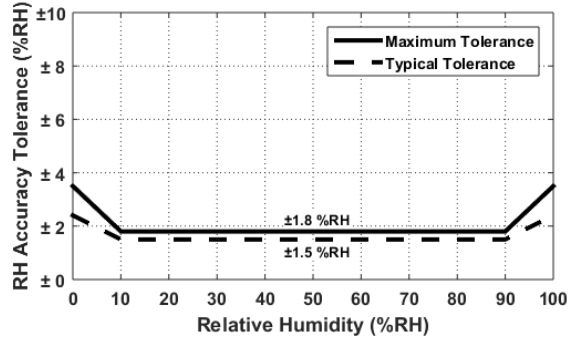

MVH4002D

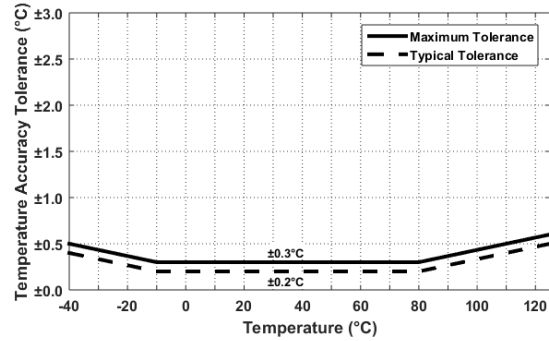
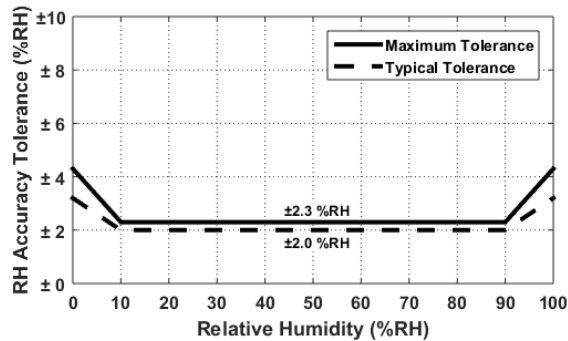

MVH4003D

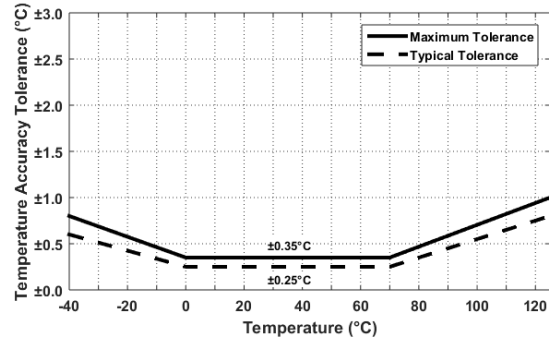
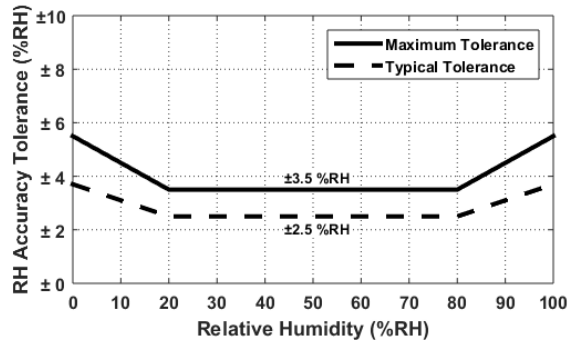

MVH4004D

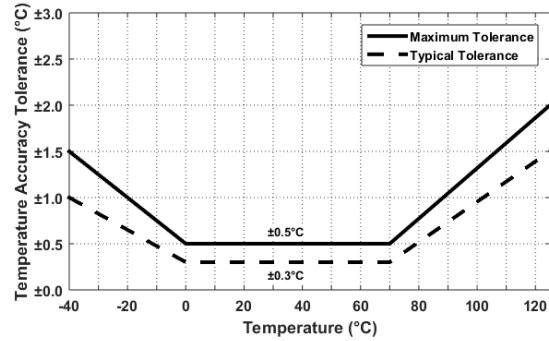
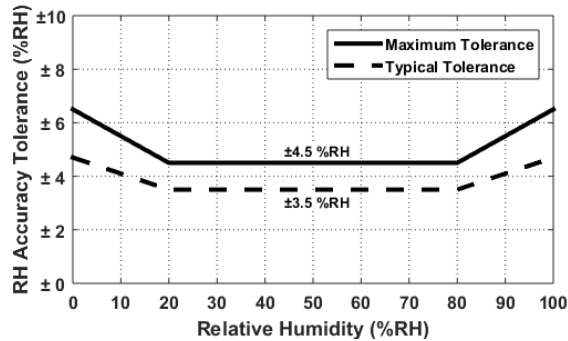

Fig. 4: Relative humidity and temperature tolerances (RH tolerances given at $T_A = +25^\circ\text{C}$).

The typical relative humidity accuracy across temperature is shown in Fig. 5.

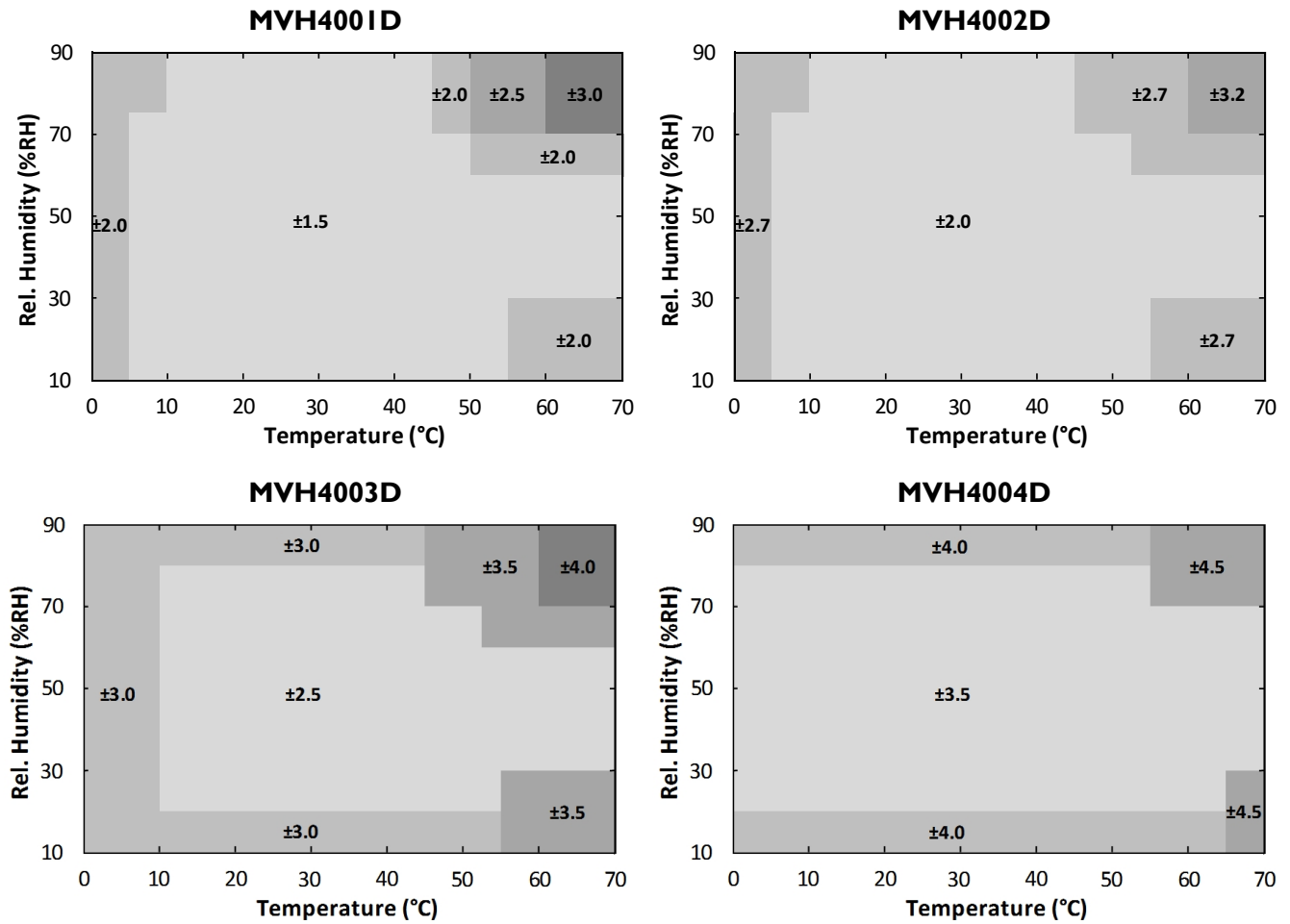

Fig. 5: Relative humidity tolerances across temperature.

5.2 Normal Operating Conditions

The sensor has been optimized to perform best in the more common temperature and humidity ranges of 10°C to 50°C and 20% RH to 80% RH (non-condensing), respectively. If operated outside of these conditions for extended periods of time, especially at high humidity levels, the sensors may exhibit an offset. In most cases, this offset is temporary and will gradually disappear once the sensor is returned to normal temperature and humidity conditions. The amount of the shift and the duration of the offset vary depending on the duration of exposure and the severity of the relative humidity and temperature conditions. The time needed for the offset to disappear can be decreased by using the procedure described in Section 8 of this datasheet.

6 User Guide

6.1 Sensor Communications

The MVH4000D series sensors communicate using the Inter-IC (I²C) standard bus protocol. To accommodate multiple devices, the protocol uses two bi-directional open-drain lines: a Serial Data Line (SDA) and a Serial Clock Line (SCL). Because these are open-drain lines, pull-up resistors to VDD must be provided as shown in Fig. 6. Several slave devices can share the I²C bus, but only one master device can be present on the line.

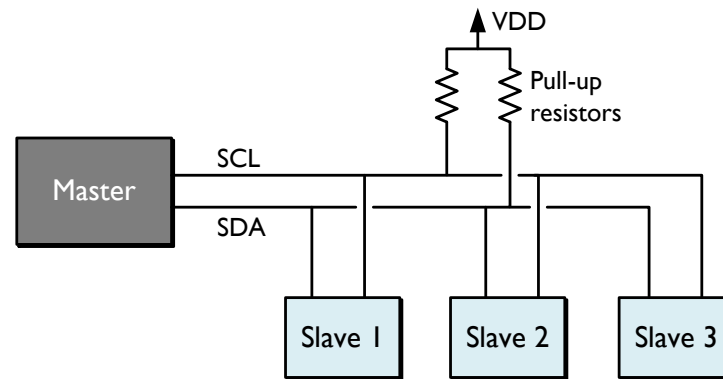

Fig. 6: Diagram of an I²C interconnect with one master and three slave devices.

Each transmission is initiated when the master sends a '0' start bit (S), and the transmission is terminated when the master sends a '1' stop bit (P). **These bits are exclusively transmitted while the SCL line is high.** The waveforms corresponding to these conditions are illustrated in Fig. 7.

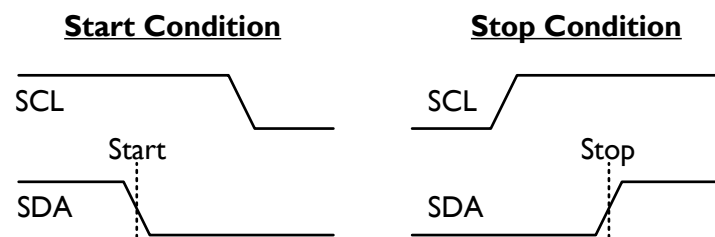

Fig. 7: I²C bus start and stop conditions.

Once the start condition has been sent, the SCL line is toggled at the prescribed data-rate, clocking subsequent data transfers. Data on the SDA line is always sampled on the rising edge of the SCL line and must remain stable while SCL is high to prevent false Start or Stop conditions (see Fig. 7).

Following the start bit, address bits select the device targeted for communications and a read/write bit indicates the transfer direction of any subsequent data. The master sends the unique 7-bit address of the desired device and a read/write bit set to '1' to indicate a read from slave to master or to '0' to indicate a write from master to slave. All transfers consist of eight data bits and one response bit set to '0' for Acknowledge (ACK) or '1' for Not Acknowledge (NACK). After the acknowledge signal is received another data byte can be transferred, or the communication can be stopped with a stop bit.

An MVH4000D series sensor operates as a slave on the I²C bus and supports data rates of up to 400 kHz in accordance with the I²C protocol. The default address of the sensor is 0x54. Custom I²C addresses can be provided upon request (please contact support@mems-vision.com for details). The sensor can be interfaced with any I²C master such as a microcontroller, and the master is responsible for generating the SCL signal for all communications with the MVH4000D series sensor.

The official I²C-bus specification and user manual documentation can be found at:

<https://www.nxp.com/docs/en/user-guide/UM10204.pdf>

The MVH4000D series sensors are equipped with different commands to configure the chip and to perform measurement as described in Table 3.

Table 3: Commands Code and Description.

Command Code (HEX)	Description
0xE3	Hold Temperature Measurement
0xF3	No-hold Temperature Measurement
0xE5	Hold Humidity and Temperature Measurement
0xF5	No-hold Humidity and Temperature Measurement
0xA7	Read Register
0xA6	Write Register
0x30	Stop Periodic Measurements
0xD7	Read Sensor ID

The Hold and No-hold commands will be described in Section 6.2, and the read and write register commands will be described in Section 6.5. The MVH4000D sensor can measure only temperature or both humidity and temperature as described in Table 4. Both options return fully calibrated measurements that can be converted to humidity and temperature readings using the equations in Section 6.2.3.

Table 4: Measurement Command Modes.

Measurement Command Mode	Description	Number of data bytes sent on the I ² C bus
Temperature	The chip only measures temperature and sends the 14-bit result once the measurement is complete.	2 bytes + 1 byte CRC
Humidity and Temperature	The chip measures humidity and temperature and sends the 14-bit humidity result followed by the 14-bit temperature result once the measurement is complete.	4 bytes + 1 byte CRC

6.2 Performing Measurements with the MVH4000D Series Sensors

There are two types of measurement commands:

1. Hold measurement commands: The MVH4000D series sensor holds the SCL line low during the measurement and releases the SCL line when the measurement is complete. This lets the master know exactly when the measurement has finished. Using this mode will prevent the master from communicating with any other slave until the measurement is complete. Note that the minimum frequency for the SCL clock in this mode is 200 kHz.
2. No-hold measurement commands: The MVH4000D series sensor does not hold the SCL line low, and the master is free to initiate communication with other slaves while the chip is performing the measurement. To obtain the measurement data, the master must request the result from the chip after the expected conversion time which depends on the measurement resolution as summarized in Section 6.2.4. There is no minimum clock frequency when in this mode.

6.2.1 Performing a Hold Measurement

A hold measurement sequence consists of the following steps, as illustrated in Fig. 8. Wake up the MVH4000D series sensor from sleep mode by sending its I²C address with a write bit, and initiate a measurement by sending the desired hold measurement command. Change the direction of communication by sending a start bit, the MVH4000D I²C address, and a read bit. The SCL line is held low by the sensor during the measurement process, which prevents the master from initiating any communications with other slaves on the bus. Once the requested measurement is completed by the MVH4000D series sensor, the SCL line is released and the chip waits for the SCL clock signal to send the results. The sensor will then transmit the requested measurement data on the bus for the master to capture.

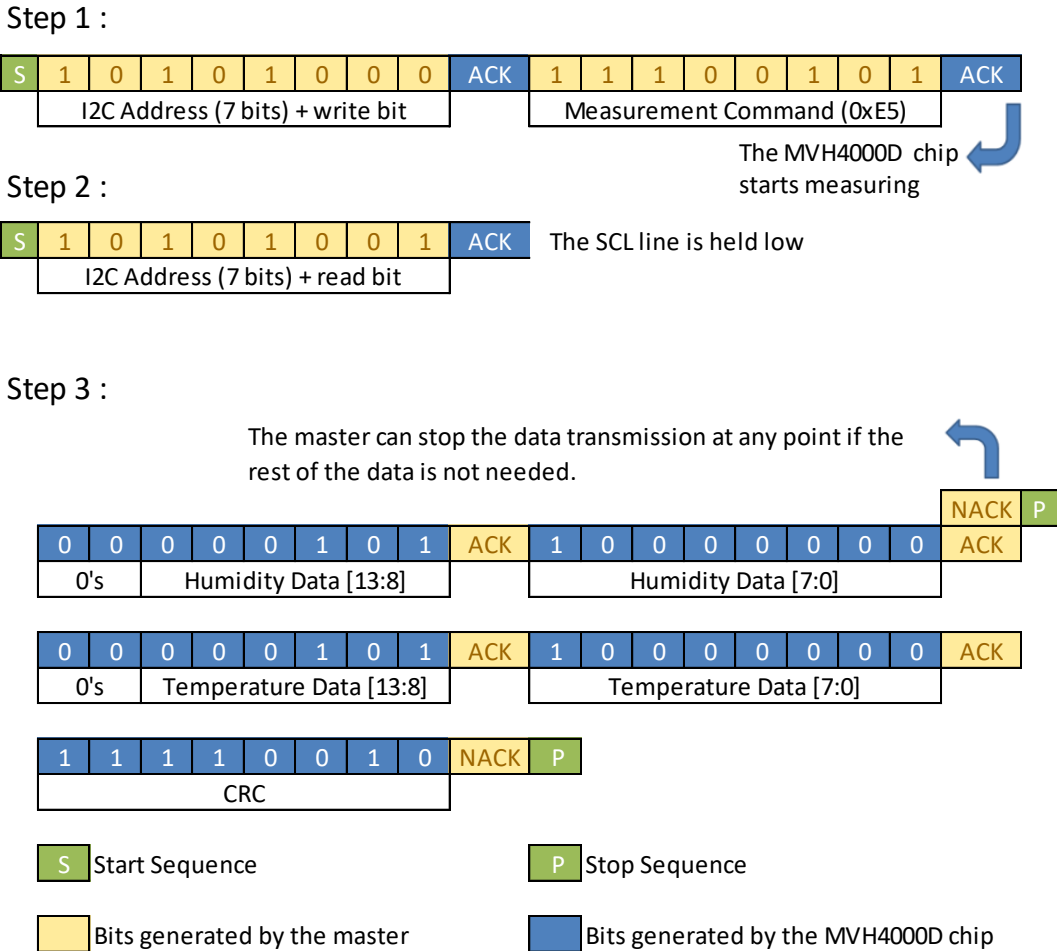

Fig. 8: Typical hold measurement sequence for a humidity and temperature command.

6.2.2 Performing a No-Hold Measurement

A no-hold measurement sequence consists of the following steps, as illustrated in Fig. 9.

1. Wake up the MVH4000D series sensor from sleep mode by sending its I²C address with a write bit, and initiate a measurement by sending the desired no-hold measurement command.
2. To read the result from the MVH4000D series sensor, the master has to send the chip its I²C address and a read bit. If the measurement is completed and the result is ready, the chip will send an ACK bit and starts to send the result over the bus. If the measurement is still in progress, the chip will send a NACK bit and the master will need to try to read the result again.

Step 1 :

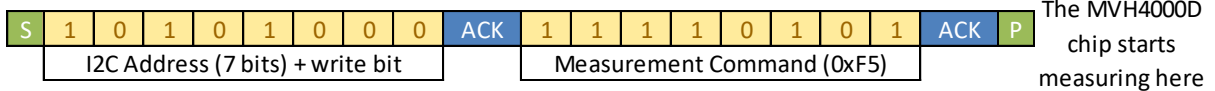

Step 2:

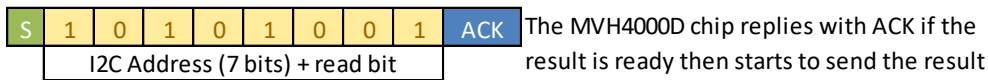
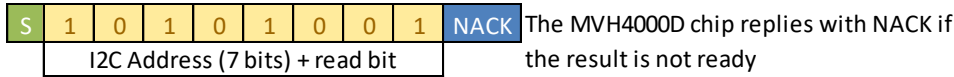

The master can stop the data transmission at any point if the rest of the data is not needed.

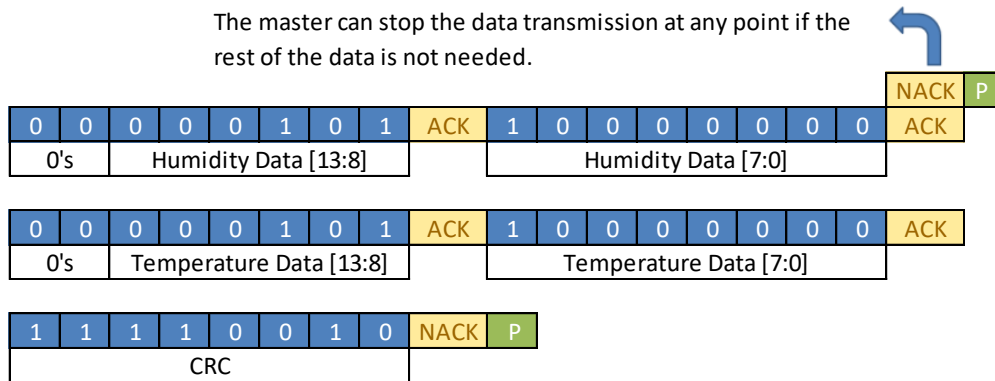

- S Start Sequence
- P Stop Sequence
- Bits generated by the master
- Bits generated by the MVH4000D chip

Fig. 9: Typical no-hold measurement sequence for a humidity and temperature command.

6.2.3 Interpreting the Data

As stated in Table 4, the measurement data can either be two or four bytes long depending on whether a temperature measurement or a humidity and temperature measurement was initiated. The most significant bit of the reading is sent first followed by the least significant bits. The humidity and temperature measurements are always scaled up to a 14-bit value regardless of the selected resolution of the sensor. The relative humidity (in percent) and the temperature (in degrees Celsius) are obtained as follows:

$$\text{Humidity } [\%RH] = \frac{\text{Humidity}[13:0]}{2^{14}-1} * 100$$

$$\text{Temperature } [^{\circ}C] = \frac{\text{Temperature } [13:0]}{2^{14}-1} * 165 - 40$$

6.2.4 Measurement Conversion Times

The MVH4000D series sensors are designed to have relatively fast conversion times. The conversion time depends on the resolution of the measurement and the command type (temperature or humidity and temperature). Table 5 summarizes the conversion times for different resolutions.

Table 5: Conversion Times.

Measurement	Resolution (bits)	Measurement Time (ms)
Temperature	8	0.37
	10	0.45
	12	0.60
	14	0.91
Humidity and Temperature ¹	8	0.64
	10	0.80
	12	1.04
	14	1.70

¹ Assuming the same resolution settings for both humidity and temperature measurements.

6.2.5 CRC Checksum Calculation

An 8-bit CRC checksum is transmitted after each measurement so the user can check for data corruption during communications if desired. The properties of the CRC algorithm used are summarized in Table 6, and the CRC is based on all 4 bytes of measurement data (2 bytes of humidity data followed by 2 bytes of temperature data). For temperature-only measurements, the 2 bytes of humidity data are set to be all 0's for the CRC calculation.

Table 6: CRC Checksum Properties.

Property	Value
Input Data Width	32 bits
CRC Width	8 bits
Polynomial	0x1D [$x^8 + x^4 + x^3 + x^2 + 1$]
Initial Value	0xFF
Final XOR Value	0x00
Reflect Input	No
Reflect Output	No
Example	CRC (0x05800580) = 0xF2

6.3 Periodic Measurement Mode

The MVH4000D sensors can also be configured to measure at regular intervals without user intervention, and the process to enable this mode is described in Section 6.6.2. In this mode, the user can read the latest relative humidity / temperature data by issuing a data fetch sequence, which consists of sending the MVH4000D I²C address with a read bit. The sensor will then send the latest measurement result over the I²C bus. The data fetch sequence is illustrated in Fig. 10.

Step 1 :



Step 2:

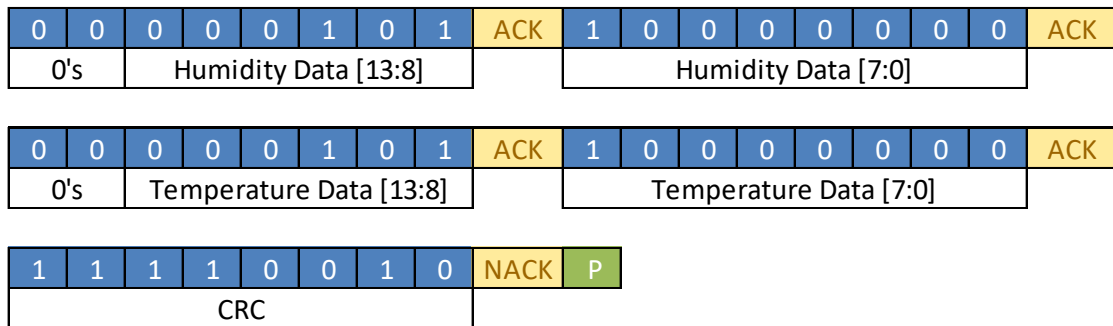

Fig. 10: Sequence to retrieve the latest results in periodic measurement mode.

The frequency of the periodic measurements can be set using the configuration registers. Section 6.5 describes how these registers are accessed, and Section 6.6.2 provides the register settings needed to configure and activate the periodic measurements.

When the periodic measurement mode is active, the only commands the chip will respond to are the data fetch command, and a command to stop the periodic measurements. The command to stop periodic measurements is issued by sending the I²C address with a write bit, followed by the command 0x30, as shown in Fig. 11. Once the periodic measurements have been stopped, the chip returns to sleep and is ready to accept all valid I²C commands.

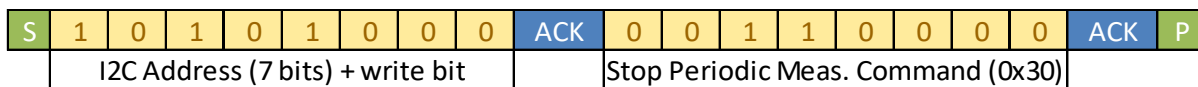

Fig. 11: Sequence to stop periodic measurements.

6.4 Alert Feature

The MVH4000D has an optional Alert Feature that can be configured in two ways as follows:

1. The Alert pin can be used to indicate when a measurement is active in Periodic Measurement Mode. This is the default behavior of the Alert pin upon power-up.
2. The Alert pin can be used to trigger an interrupt on the system microcontroller so an appropriate action can be taken if the temperature or humidity is outside of the desired limits.

These features will be described in the following two sub-sections.

6.4.1 Alert Pin – Measurement Active

The default behavior of the Alert pin is to indicate when a measurement is active if Periodic Measurement Mode is used. Upon power-up, the Alert pin will have a logic high level. When periodic measurement mode is activated, the Alert pin will have a logic low level between measurements, and a logic high during measurements. This behavior is shown in Fig. 12, and the Alert pin will exhibit this functionality when the temperature and humidity alerts are disabled (see Table 10).

If Periodic Measurement Mode is not active, the Alert pin will remain at a logic high level.

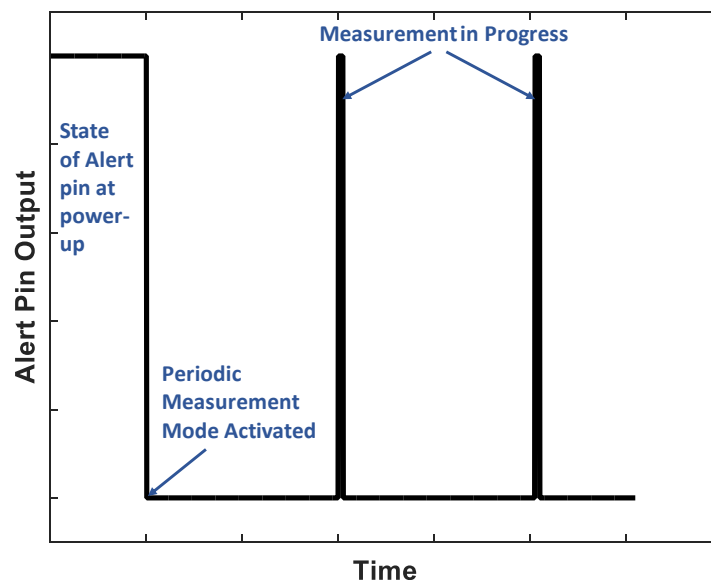

Fig. 12: Alert Pin Functionality – Measurement Active Indicator.

6.4.2 Alert Pin – Humidity / Temperature Threshold Detection

The Alert pin can also be configured to send a signal when a humidity / temperature threshold is exceeded, and the system needs to take action. In this mode, the Alert feature has a programmable threshold, polarity, and hysteresis, and can apply to both temperature and humidity measurements. An example of the functionality of the Alert feature can be seen in Fig. 13.

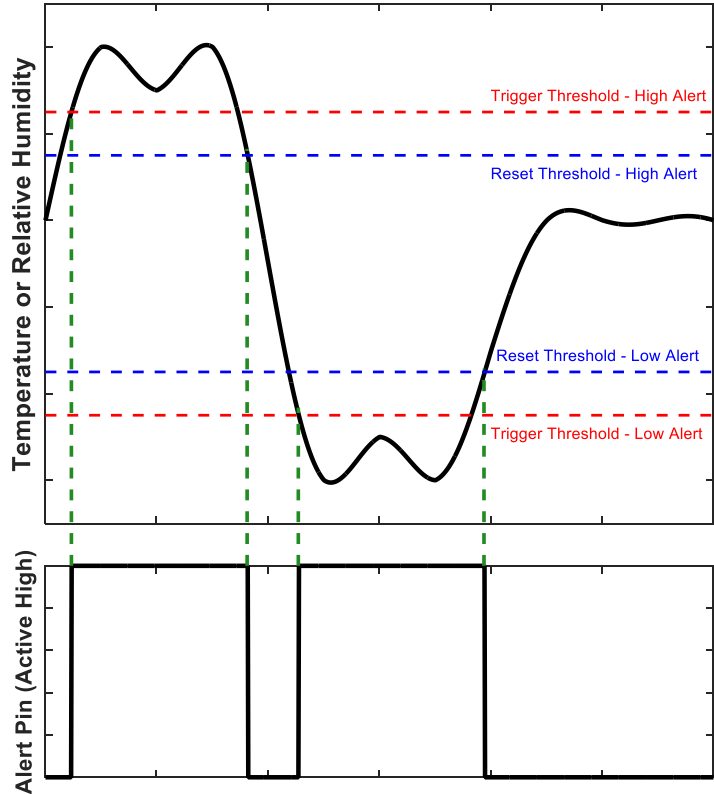

Fig. 13: Example of Alert Pin Functionality in Humidity / Temperature Detection Mode.

The registers used to enable the Alert feature and the temperature / humidity thresholds are shown in Table 10. When the Alert feature is enabled for either humidity or temperature in Periodic Measurement Mode, an additional status byte will precede the measurement values. The format of the bits returned from the MVH4000D sensor when any Alert is enabled during Periodic Measurement Mode is shown in Fig. 14, and the meaning of the Alert status bits are defined in Table 7.

Table 7: Alert status bits.

Status Bit	Meaning
TH	High (0b1) if the Temperature High Alert is triggered
TL	High (0b1) if the Temperature Low Alert is triggered
HH	High (0b1) if the Humidity High Alert is triggered
HL	High (0b1) if the Humidity Low Alert is triggered

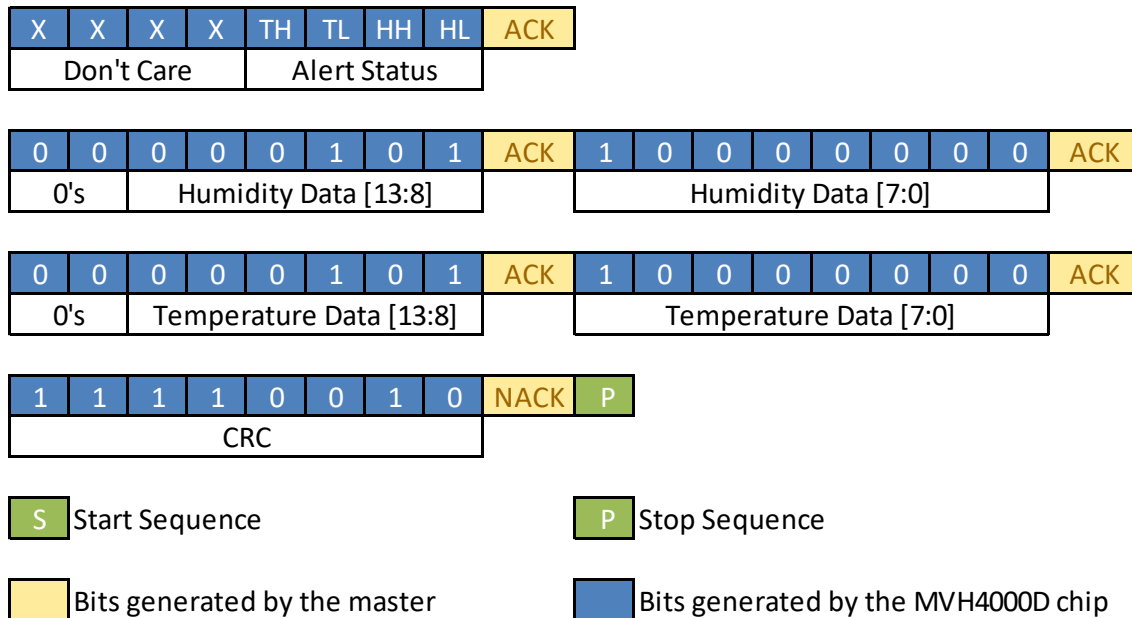

Fig. 14: Data returned from MVH4000D chip when the Alert feature is enabled in Periodic Measurement Mode.

6.5 Accessing Configurable Sensor Registers

The MVH4000D measurement settings can be changed by accessing the appropriate configuration registers and altering their values. This can be done by issuing a Write Register command. A Read Register command is also available to read the configuration register values. These commands will be described in this section, and the configuration registers and settings will be described in Section 6.6.

While accessing specific configuration bits in any register, all the other bits in that register must be left unchanged. To write a specific bit/bits in a register, the process is as follows:

1. Read the entire configuration register using the sequence described in Section 6.5.1.
2. Mask the register such that only the required bits are changed, according to the configuration parameters in Section 6.6.
3. Write the new register back to the appropriate address using the Write Register command sequence described in Section 6.5.2.

All configuration registers will be reset to their default values if the power supply to the chip is cutoff.

6.5.1 Read Register Command

A Read Register sequence consists of the following steps, as illustrated in Fig. 15.

1. Wake up the MVH4000D series sensor from sleep mode by sending its I²C address with a write bit, and initiate a Read Register command by sending the command 0xA7.
2. Send the address of the register to be read.
3. Change the direction of communication by sending the MVH4000D I²C address and a read bit. The chip will send the data stored in this register, after which the master replies with a NACK and a STOP bit.

Step 1 :

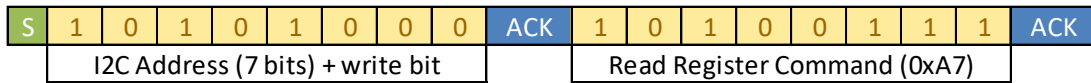

Step 2 :

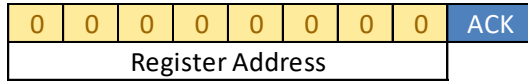

Step 3 :

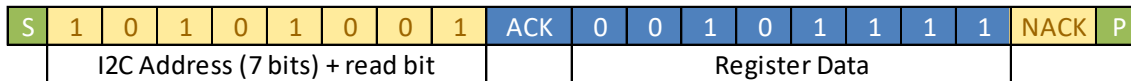

S Start Sequence

P Stop Sequence

Bits generated by the master

Bits generated by the MVH4000D chip

Fig. 15: Read Register command sequence.

6.5.2 Write Register Command

A Write Register sequence consists of the following steps, as illustrated in Fig. 16.

1. Wake up the MVH4000D series sensor from sleep mode by sending its I²C address with a write bit, and initiate a Write Register command by sending the command 0xA6.
2. Send the address of the register to write.
3. Send the data to be stored in this register followed by a STOP bit.

Step 1 :

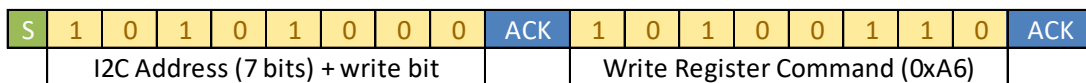

Step 2 :

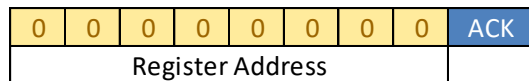

Step 3 :

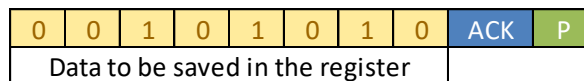

S Start Sequence

P Stop Sequence

Bits generated by the master

Bits generated by the MVH4000D chip

Fig. 16: Write Register command sequence.

6.6 Configuration Bits

6.6.1 Setting the Measurement Resolution

The chip can be configured to perform measurements at different humidity and temperature resolutions by using the Read and Write Register commands with the appropriate register address. There are four separate resolution settings for the temperature and humidity measurements, as summarized in Table 8.

Table 8: Temperature and Humidity Measurement Resolution Settings.

Setting	Register Address (HEX)	Bits	Description
Resolution for temperature measurement	0x00	<1:0>	0b00 for 8 bits
			0b01 for 10 bits
			0b10 for 12 bits
			0b11 for 14 bits
Resolution for humidity measurement	0x00	<3:2>	0b00 for 8 bits
			0b01 for 10 bits
			0b10 for 12 bits
			0b11 for 14 bits

6.6.2 Periodic Measurement Settings

The registers that are used to activate and configure the periodic measurement settings are shown in Table 9.

Table 9: Periodic Measurement Settings.

Setting	Register Address (HEX)	Bits	Description
Activate Periodic Measurements	0x02	<7>	0b0 when periodic measurements are deactivated
			0b1 to activate periodic measurements
Frequency of Periodic Measurements	0x02	<5:4>	0b00 for a measurement every 0.5 s
			0b01 for a measurement every 1 s
			0b10 for a measurement every 2.5 s

6.6.3 Alert Feature Settings

Table 10: Alert Feature Settings.

Setting	Register Address (HEX)	Bits	Description																																																											
Alert Pin Polarity in Humidity / Temperature Threshold Detection Mode	0x02	<0>	0b0 Alert pin is active high when triggered																																																											
			0b1 Alert pin is active low when triggered																																																											
Alert Enable Settings	0x03	<3:0>	<p>Enable the Alert feature when thresholds are surpassed as follows:</p> <p>Bit <0>: RH Low alert enable Bit <1>: RH High alert enable Bit <2>: Temperature Low alert enable Bit <3>: Temperature High alert enable</p> <p>Setting a bit to 0b1 means this specific alert condition is enabled, and setting a bit to 0b0 means this specific alert condition is disabled.</p>																																																											
Trigger Threshold for Temperature High Alert	0x08, 0x07	<13:0>	<p>Registers 0x08, 0x07 set the threshold for when the "Temperature High" alert is triggered. When the measured temperature goes above the value in this register, the Alert pin will be triggered.</p> <p>The temperature used for the threshold is composed of 14-bits as follows:</p> <table border="1" style="margin-left: auto; margin-right: auto;"> <thead> <tr> <th colspan="7">Register 0x08</th> <th colspan="7">Register 0x07</th> </tr> </thead> <tbody> <tr> <td>0</td><td>0</td><td>0</td><td>0</td><td>0</td><td>0</td><td>1</td><td>0</td><td>1</td><td>1</td><td>0</td><td>0</td><td>0</td><td>0</td><td>0</td><td>0</td><td>0</td> </tr> <tr> <td colspan="7">0's</td> <td colspan="7">Trigger Threshold [13:8]</td> </tr> <tr> <td colspan="7"></td> <td colspan="7">Trigger Threshold [7:0]</td> </tr> </tbody> </table> <p>This 14-bit value is converted into a temperature threshold using the same conversion equation shown in Section 6.2.3.</p>	Register 0x08							Register 0x07							0	0	0	0	0	0	1	0	1	1	0	0	0	0	0	0	0	0's							Trigger Threshold [13:8]														Trigger Threshold [7:0]						
Register 0x08							Register 0x07																																																							
0	0	0	0	0	0	1	0	1	1	0	0	0	0	0	0	0																																														
0's							Trigger Threshold [13:8]																																																							
							Trigger Threshold [7:0]																																																							
Reset Threshold for Temperature High Alert	0x06, 0x05	<13:0>	<p>Registers 0x06, 0x05 set the threshold for when the "Temperature High" alert condition is reset. After the alert is triggered, it will only be reset after the measured temperature goes below the value in this register.</p> <p>The temperature used for the threshold is composed of 14-bits as follows:</p> <table border="1" style="margin-left: auto; margin-right: auto;"> <thead> <tr> <th colspan="7">Register 0x06</th> <th colspan="7">Register 0x05</th> </tr> </thead> <tbody> <tr> <td>0</td><td>0</td><td>0</td><td>0</td><td>0</td><td>0</td><td>1</td><td>0</td><td>1</td><td>1</td><td>0</td><td>0</td><td>0</td><td>0</td><td>0</td><td>0</td> </tr> <tr> <td colspan="7">0's</td> <td colspan="7">Reset Threshold [13:8]</td> </tr> <tr> <td colspan="7"></td> <td colspan="7">Reset Threshold [7:0]</td> </tr> </tbody> </table> <p>This 14-bit value is converted into a temperature threshold using the same conversion equation shown in Section 6.2.3.</p>	Register 0x06							Register 0x05							0	0	0	0	0	0	1	0	1	1	0	0	0	0	0	0	0's							Reset Threshold [13:8]														Reset Threshold [7:0]							
Register 0x06							Register 0x05																																																							
0	0	0	0	0	0	1	0	1	1	0	0	0	0	0	0																																															
0's							Reset Threshold [13:8]																																																							
							Reset Threshold [7:0]																																																							

<p>Trigger Threshold for Temperature Low Alert</p>	<p>0x0A, 0x09</p>	<p><13:0></p>	<p>Registers 0x0A, 0x09 set the threshold for when the "Temperature Low" alert is triggered. When the measured temperature goes below the value in this register, the Alert pin will be triggered.</p> <p>The temperature used for the threshold is composed of 14-bits as follows:</p> <table border="1" data-bbox="824 411 1409 485"> <tr> <th colspan="7">Register 0x0A</th> <th colspan="7">Register 0x09</th> </tr> <tr> <td>0</td><td>0</td><td>0</td><td>0</td><td>0</td><td>1</td><td>0</td><td>1</td><td>1</td><td>0</td><td>0</td><td>0</td><td>0</td><td>0</td><td>0</td><td>0</td> </tr> <tr> <td colspan="7">0's</td> <td colspan="7">Trigger Threshold [13:8]</td> <td colspan="7">Trigger Threshold [7:0]</td> </tr> </table> <p>This 14-bit value is converted into a temperature threshold using the same conversion equation shown in Section 6.2.3.</p>	Register 0x0A							Register 0x09							0	0	0	0	0	1	0	1	1	0	0	0	0	0	0	0	0's							Trigger Threshold [13:8]							Trigger Threshold [7:0]						
Register 0x0A							Register 0x09																																															
0	0	0	0	0	1	0	1	1	0	0	0	0	0	0	0																																							
0's							Trigger Threshold [13:8]							Trigger Threshold [7:0]																																								
<p>Reset Threshold for Temperature Low Alert</p>	<p>0x0C, 0x0B</p>	<p><13:0></p>	<p>Registers 0x0C, 0x0B set the threshold for when the "Temperature Low" alert condition is reset. After the alert is triggered, it will only be reset after the measured temperature goes above the value in this register.</p> <p>The temperature used for the threshold is composed of 14-bits as follows:</p> <table border="1" data-bbox="824 816 1409 890"> <tr> <th colspan="7">Register 0x0C</th> <th colspan="7">Register 0x0B</th> </tr> <tr> <td>0</td><td>0</td><td>0</td><td>0</td><td>0</td><td>1</td><td>0</td><td>1</td><td>1</td><td>0</td><td>0</td><td>0</td><td>0</td><td>0</td><td>0</td><td>0</td> </tr> <tr> <td colspan="7">0's</td> <td colspan="7">Reset Threshold [13:8]</td> <td colspan="7">Reset Threshold [7:0]</td> </tr> </table> <p>This 14-bit value is converted into a temperature threshold using the same conversion equation shown in Section 6.2.3.</p>	Register 0x0C							Register 0x0B							0	0	0	0	0	1	0	1	1	0	0	0	0	0	0	0	0's							Reset Threshold [13:8]							Reset Threshold [7:0]						
Register 0x0C							Register 0x0B																																															
0	0	0	0	0	1	0	1	1	0	0	0	0	0	0	0																																							
0's							Reset Threshold [13:8]							Reset Threshold [7:0]																																								
<p>Trigger Threshold for Relative Humidity High Alert</p>	<p>0x10, 0x0F</p>	<p><13:0></p>	<p>Registers 0x10, 0x0F set the threshold for when the "RH High" alert is triggered. When the measured RH goes above the value in this register, the Alert pin will be triggered.</p> <p>The humidity used for the threshold is composed of 14-bits as follows:</p> <table border="1" data-bbox="824 1186 1409 1260"> <tr> <th colspan="7">Register 0x10</th> <th colspan="7">Register 0x0F</th> </tr> <tr> <td>0</td><td>0</td><td>0</td><td>0</td><td>0</td><td>1</td><td>0</td><td>1</td><td>1</td><td>0</td><td>0</td><td>0</td><td>0</td><td>0</td><td>0</td><td>0</td> </tr> <tr> <td colspan="7">0's</td> <td colspan="7">Trigger Threshold [13:8]</td> <td colspan="7">Trigger Threshold [7:0]</td> </tr> </table> <p>This 14-bit value is converted into a humidity threshold using the same conversion equation shown in Section 6.2.3.</p>	Register 0x10							Register 0x0F							0	0	0	0	0	1	0	1	1	0	0	0	0	0	0	0	0's							Trigger Threshold [13:8]							Trigger Threshold [7:0]						
Register 0x10							Register 0x0F																																															
0	0	0	0	0	1	0	1	1	0	0	0	0	0	0	0																																							
0's							Trigger Threshold [13:8]							Trigger Threshold [7:0]																																								
<p>Reset Threshold for Relative Humidity High Alert</p>	<p>0x0E, 0x0D</p>	<p><13:0></p>	<p>Registers 0x0E, 0x0D set the threshold for when the "RH High" alert condition is reset. After the alert is triggered, it will only be reset after the measured RH goes below the value in this register.</p> <p>The humidity used for the threshold is composed of 14-bits as follows:</p> <table border="1" data-bbox="824 1591 1409 1665"> <tr> <th colspan="7">Register 0x0E</th> <th colspan="7">Register 0x0D</th> </tr> <tr> <td>0</td><td>0</td><td>0</td><td>0</td><td>0</td><td>1</td><td>0</td><td>1</td><td>1</td><td>0</td><td>0</td><td>0</td><td>0</td><td>0</td><td>0</td><td>0</td> </tr> <tr> <td colspan="7">0's</td> <td colspan="7">Reset Threshold [13:8]</td> <td colspan="7">Reset Threshold [7:0]</td> </tr> </table> <p>This 14-bit value is converted into a humidity threshold using the same conversion equation shown in Section 6.2.3.</p>	Register 0x0E							Register 0x0D							0	0	0	0	0	1	0	1	1	0	0	0	0	0	0	0	0's							Reset Threshold [13:8]							Reset Threshold [7:0]						
Register 0x0E							Register 0x0D																																															
0	0	0	0	0	1	0	1	1	0	0	0	0	0	0	0																																							
0's							Reset Threshold [13:8]							Reset Threshold [7:0]																																								

<p>Trigger Threshold for Relative Humidity Low Alert</p>	<p>0x12, 0x11</p>	<p><13:0></p>	<p>Registers 0x12, 0x11 set the threshold for when the "RH Low" alert is triggered. When the measured RH goes below the value in this register, the Alert pin will be triggered.</p> <p>The humidity used for the threshold is composed of 14-bits as follows:</p> <table border="1" data-bbox="824 373 1409 449"> <tr> <th colspan="7">Register 0x12</th> <th colspan="7">Register 0x11</th> </tr> <tr> <td>0</td><td>0</td><td>0</td><td>0</td><td>0</td><td>1</td><td>0</td><td>1</td><td>1</td><td>0</td><td>0</td><td>0</td><td>0</td><td>0</td><td>0</td><td>0</td> </tr> <tr> <td colspan="7">0's</td> <td colspan="7">Trigger Threshold [7:0]</td> </tr> </table> <p>This 14-bit value is converted into a humidity threshold using the same conversion equation shown in Section 6.2.3.</p>	Register 0x12							Register 0x11							0	0	0	0	0	1	0	1	1	0	0	0	0	0	0	0	0's							Trigger Threshold [7:0]						
Register 0x12							Register 0x11																																								
0	0	0	0	0	1	0	1	1	0	0	0	0	0	0	0																																
0's							Trigger Threshold [7:0]																																								
<p>Reset Threshold for Relative Humidity Low Alert</p>	<p>0x14, 0x13</p>	<p><13:0></p>	<p>Registers 0x14, 0x13 sets the threshold for when the "RH Low" alert condition is reset. After the alert is triggered, it will only be reset after the measured RH goes above the value in this register.</p> <p>The humidity used for the threshold is composed of 14-bits as follows:</p> <table border="1" data-bbox="824 779 1409 854"> <tr> <th colspan="7">Register 0x14</th> <th colspan="7">Register 0x13</th> </tr> <tr> <td>0</td><td>0</td><td>0</td><td>0</td><td>0</td><td>1</td><td>0</td><td>1</td><td>1</td><td>0</td><td>0</td><td>0</td><td>0</td><td>0</td><td>0</td><td>0</td> </tr> <tr> <td colspan="7">0's</td> <td colspan="7">Reset Threshold [7:0]</td> </tr> </table> <p>This 14-bit value is converted into a humidity threshold using the same conversion equation shown in Section 6.2.3.</p>	Register 0x14							Register 0x13							0	0	0	0	0	1	0	1	1	0	0	0	0	0	0	0	0's							Reset Threshold [7:0]						
Register 0x14							Register 0x13																																								
0	0	0	0	0	1	0	1	1	0	0	0	0	0	0	0																																
0's							Reset Threshold [7:0]																																								

6.7 Reading the Sensor ID Number

The sensor ID is a 32-bit number that can be used to identify a given device. Each sensor has a unique ID that can be used for traceability. The sequence to read the sensor ID is as follows:

1. Wake up the MVH4000D series sensor from sleep mode by sending its I²C address with a write bit, and initiate a Read Sensor ID command by sending the command 0xD7.
2. Change the direction of communication by sending the MVH4000D I²C address and a read bit. The SCL line is held low by the sensor while it retrieves the ID from internal memory to prevent data corruption. The sensor takes approximately 10 μs to retrieve the ID from internal memory.
3. Once the request is completed by the MVH4000D series sensor, the SCL line is released and the chip waits for the SCL clock signal to send the results. The sensor will then transmit the 4-byte sensor ID on the bus for the master to capture, MSB first.

The command sequence to read the sensor ID is illustrated in Fig. 17.

Step 1 :

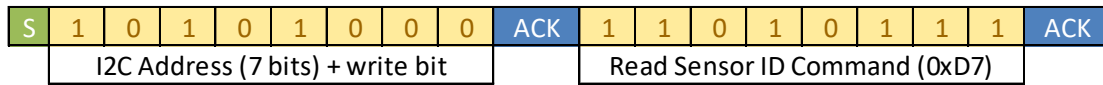

Step 2 :

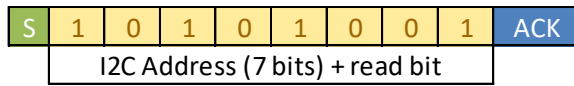

The MVH4000D chip reads the sensor ID from internal memory, and the SCL line is held low. This process takes ~10µs.

Step 3 :

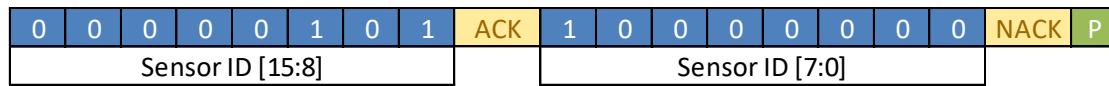
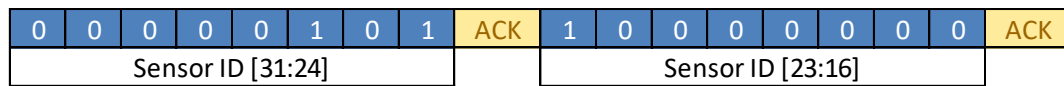

S Start Sequence

P Stop Sequence

Bits generated by the master

Bits generated by the MVH4000D chip

Fig. 17: Read Sensor ID command sequence.

6.8 I²C Timing Specifications

The timing diagram for all I²C communications is shown in Fig. 18, and the minimum and maximum values for each critical timing parameter (e.g., setup times, hold times) are listed in Table 11.

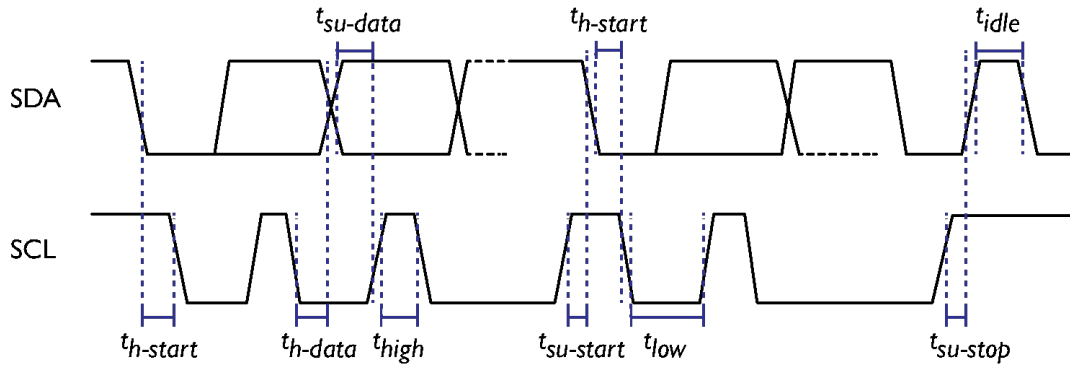

Fig. 18: I²C timing diagram.

Table 11: I²C Timing Parameters.

Parameter	Symbol	Min	Max	Units
SCL Frequency	f_{SCL}	0	400	kHz
Start bit setup time	$t_{su-start}$	0.1		μ s
Start bit hold time	$t_{h-start}$	0.1		μ s
Minimum SCL low width	t_{low}	1		μ s
Minimum SCL high width	t_{high}	0.6		μ s
Data setup time	$t_{su-data}$	0.1		μ s
Data hold time	t_{h-data}	0.5		μ s
Stop bit setup time	$t_{su-stop}$	0.1		μ s
SDA unused time between stop and start bits	t_{idle}	2.5		μ s

7 Package and PCB Information

The MVH4000D series sensors are packaged in a 2.5 × 2.5 × 0.9 mm 8-pin dual-flat no-leads (DFN)-style LGA package.

7.1 Package Drawing

The mechanical drawing of the LGA package is shown in Fig. 19, and a suitable land pattern for soldering the sensor to a PCB is shown in Fig. 20.

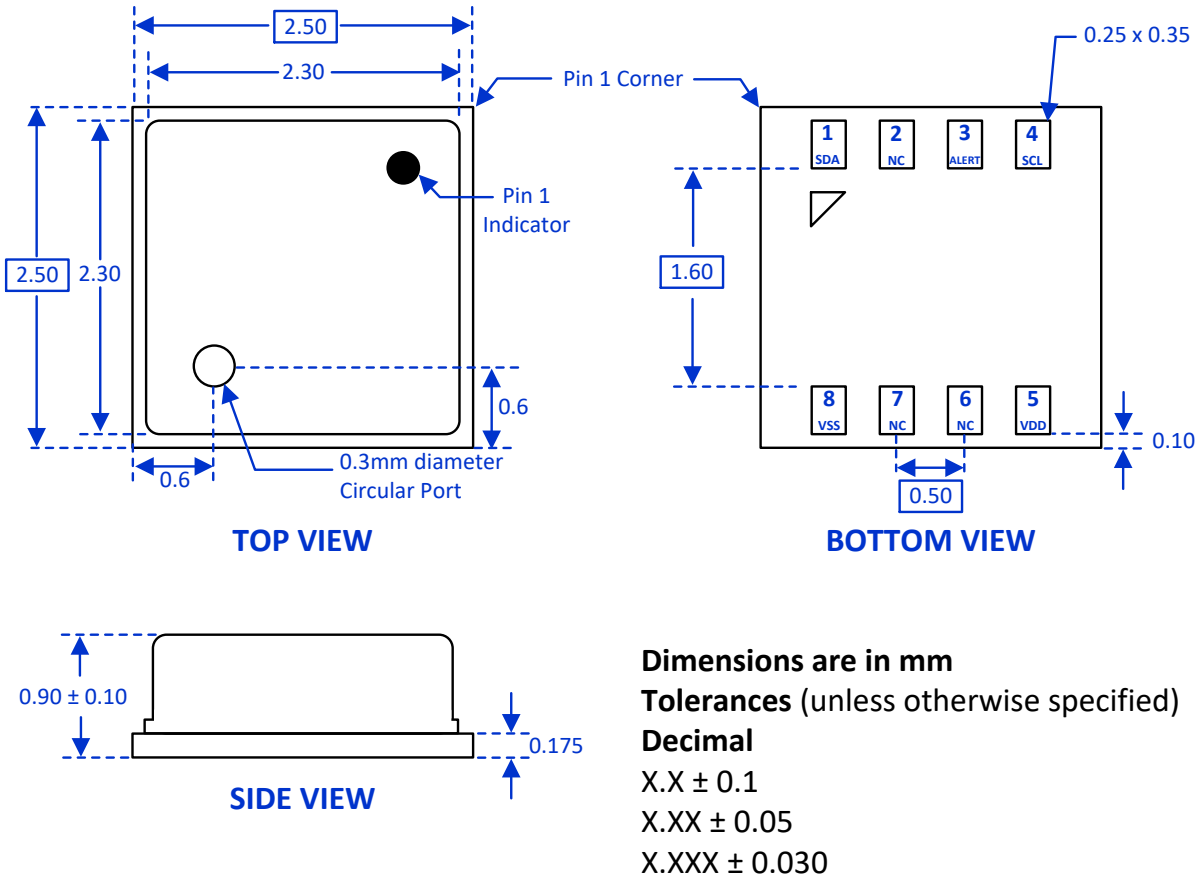

Fig. 19: LGA package drawing.

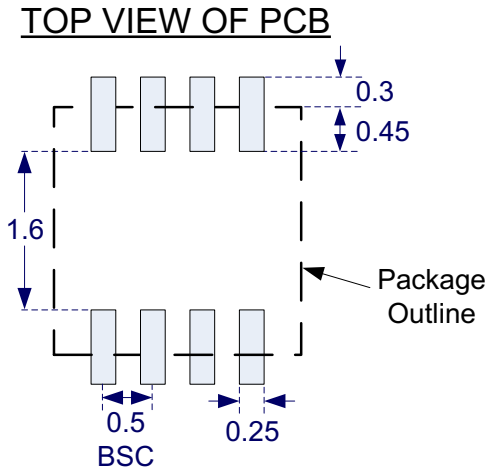

Fig. 20: LGA package land pattern [top view].

7.2 Tape and Reel Information

The MVH4000D series sensors are shipped in tape and reel packaging and enclosed in sealed anti-static bags. Standard packaging sizes are 400, 1500, and 3000 units (please contact MEMS Vision for other volumes). The tape has a 520mm leader (130 pockets) and a 410mm trailer (103 pockets). A drawing of the packaging tape is shown in Fig. 21, which also shows the sensor orientation.

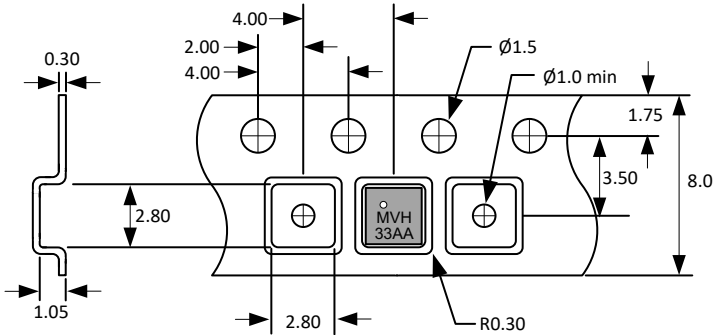

Fig. 21: Packaging tape drawing.

7.3 Soldering Information

Standard reflow ovens can be used to solder the MVH4000D series sensor to the PCB. The peak temperature (T_p) for use with the JEDEC J-STD-020D standard soldering profile is 260°C. For manual soldering, the contact time must be limited to 5 seconds at up to 350°C. In either case, if solder paste is used, it is recommended to use 'no-clean' solder paste to avoid the need to wash the PCB.

Note that reflow soldering is recommended for optimal performance. The recommended lead-free (RoHS compliant) reflow soldering profile is shown in Fig. 22.

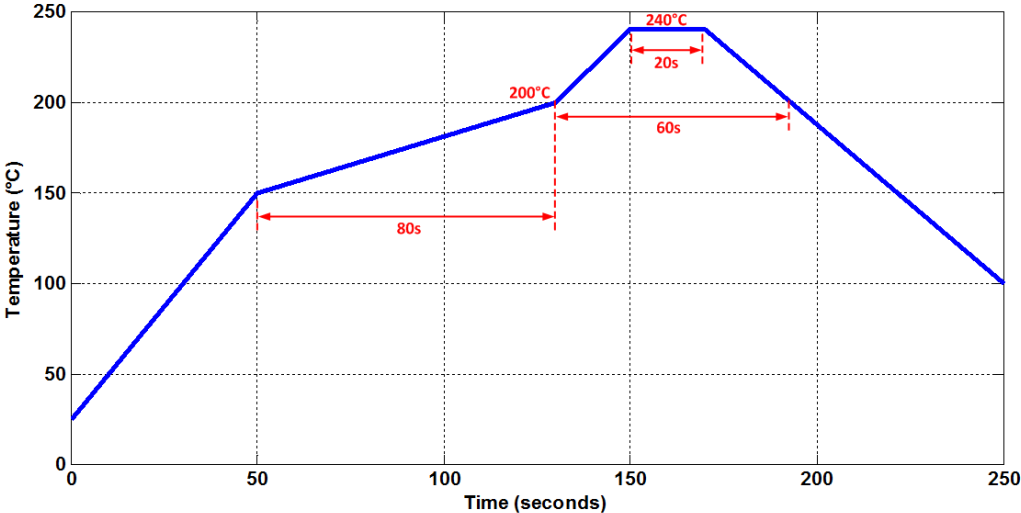

Fig. 22: Recommended lead-free soldering profile

After soldering, the humidity sensor element should be exposed to a humidity of 75% RH for at least 12 hours in order to rehydrate the element. Otherwise, there may be an initial offset in the relative humidity readings, which will slowly disappear as the sensor gets exposed to ambient conditions.

7.4 PCB Layout Considerations

When designing the PCB, undesired heat transfer paths to the MVH4000D series chip must be minimized. Excessive heat from other components on the PCB will result in inaccurate temperature and relative humidity measurements. As such, **solid metal planes for power supplies should be avoided in the vicinity of the sensor** since these will act as thermal conductors. To further reduce the heat transfer from other components on the board, openings can be milled into the PCB as shown in Fig. 23.

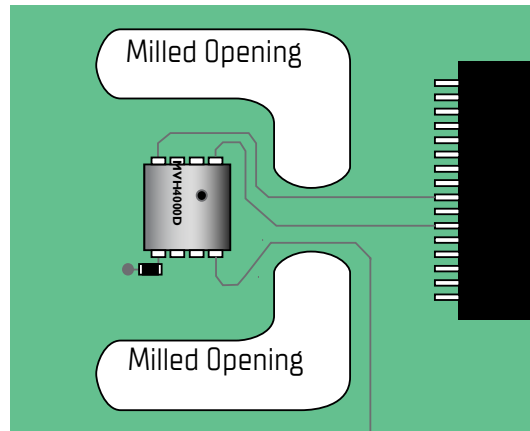

Fig. 23: Thermal isolation of sensor using milled PCB openings.

8 Storage and Handling Information

Once the sensors are removed from their original packaging, it is recommended to store them in metal-in antistatic bags. Polyethylene antistatic bags (light blue or pink in color) should be avoided as they may affect sensor accuracy.

The nominal storage conditions for the MVH4000D series chip are at temperatures in the range of 10 to 50°C and at humidity levels within the range of 20% to 60% RH. If the chip is stored outside of these ranges for extended periods of time, the relative humidity sensor readings may exhibit an offset. The sensor can be brought back to its calibration state by applying the following reconditioning procedure:

1. Baking at a temperature of 100°C with a humidity < 10% for 10 -12 hours.
2. Rehydrating the sensor at a humidity of 75% RH and a temperature between 20 to 30°C for 12 to 14 hours.

Note that the sensor may also return to its calibrated state if left at ambient conditions for a longer period of time.

© 2021 MEMS Vision Worldwide. All rights reserved.

MEMS Vision, its logo, and MoSiC[®] are trademarks or registered trademarks of MEMS Vision International Inc., Canada, and its subsidiaries in Canada and other countries.

Other trademarks used herein are the property of MEMS Vision or their respective third party owners.

The information in this document is believed to be accurate in all respects at the time of publication, but shall not be regarded as a guarantee of conditions or characteristics. MEMS Vision assumes no responsibility for errors and omissions, and disclaims responsibility for any consequences resulting from the use of information included in this document. MEMS Vision also assumes no responsibility for the functioning of features or parameters not explicitly described herein. MEMS Vision reserves the right to make changes without further notice. MEMS Vision makes no warranty, representation, or guarantee regarding the suitability of its products for any particular purpose, nor does MEMS Vision assume any liability arising out of the application or use of any product or circuit and, specifically DISCLAIMS ANY AND ALL LIABILITY, including without limitation consequential or incidental damages, as well as warranties of non-infringement of intellectual property rights of any third party.

MEMS Vision products are not designed, intended, or authorized for use in applications intended for safety, emergency stopping, or supporting or sustaining life, or for any other application in which the failure of the MEMS Vision product could create a situation where personal injury or death may occur. Should Buyer purchase or use MEMS Vision products for any such unintended or unauthorized application, Buyer shall indemnify and hold MEMS Vision harmless against all claims and damages.

www.mems-vision.com

info@mems-vision.com